

# CILINDROS Y MOTORES HIDRÁULICOS

## HYDRAULIC CYLINDERS AND MOTORS *VÉRINS ET MOTEURS HYDRAULIQUES*

### - Cilindros ISO

ISO Cylinders

*Vérins ISO* .....167

### - Accesorios

Accessories

*Accessoires* .....171

### - Cilindros Especiales

Special Cylinders

*Vérins Spéciaux* .....172

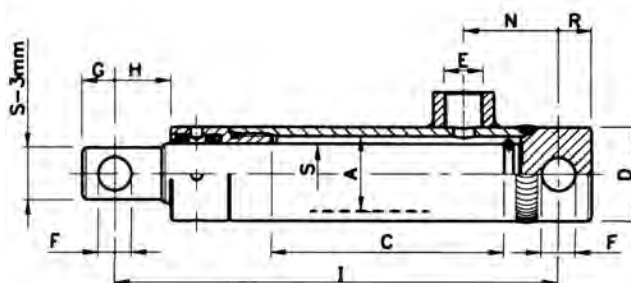
**CILINDRO SIMPLE EFECTO SIN CABEZA NI GUIAS****SINGLE ACTING CYLINDER - TYPE R (WITHOUT HEAD BUSH)****VÉRINS SIMPLE EFFET (SANS TÊTE NI GUIDES)****CARACTERÍSTICAS TÉCNICAS / TECHNICAL SPECIFICATIONS / CARACTÉRISTIQUES TECHNIQUES****Camisa** / Cylinder tube / *Alésage:* "Lucido" ISO H9, DIN 2393 St 52. 3 / *Polished Tube***Vástago** / Piston Rod / *Tige:* UNI 5332 C45**Cabeza** / Head Bush Iron / *Tête:* Hierro / *Iron* UNI 5007**Junta de Camisa** / Joint of Cylinder Tube / *Joint de tige:* PU**Rascador** / Wiper / *Racleur:* PU**Junta Tórica** / O'ring / *Joint torique statique:* Nitrilo / *Nitrile***Presión** / Pressure / *Pression:* 160 bar - 210 bar**Temperatura** / Temperature / *Temperature:* -30°C +110°C

Referencia Part No. Référence	ØS	ØA	C	I	Kg.	ØD	E	ØF	G	H	N	R	Kg./100Bar	€
SE25100	25	32	100	190	1,5	40	3/8 gas	14,2	14	24	40	14	490	92,17
SE25150			150	240	2									95,55
SE25200			200	290	2,5									98,92
SE25250			250	340	3									106,22
SE25300			300	390	3,5									109,60
SE30150	30	40	150	250	3,5	50	3/8 gas	16,4	16	26	44	15	706	103,41
SE30200			200	300	4									108,47
SE30250			250	350	5									114,65
SE30300			300	400	5,5									119,15
SE30350			350	450	6									124,77
SE30400			400	500	6,5									129,27
SE30450			450	550	7									138,26
SE30550			550	650	8									148,38
SE30700			700	800	10									161,34
SE40200	40	50	200	330	7	60	3/8 gas	22,4	22	32	48	22	1.250	131,52
SE40250			250	380	7,5									143,88
SE40300			300	430	8									147,86
SE40350			350	480	8,5									158,49
SE40400			400	530	10									163,06
SE40450			450	580	11									178,73
SE40500			500	630	12									185,47
SE40550			550	680	12,5									186,30
SE40600			600	730	13,5									200,08
SE40700			700	830	15									209,51

**CILINDRO SIMPLE EFECTO CON CABEZA Y GUIAS**  
**SINGLE ACTING CYLINDER - SERIE R (WITH HEAD BUSH)**  
**VÉRIN SIMPLE EFFET (AVEC TÊTE ET GUIDES)**

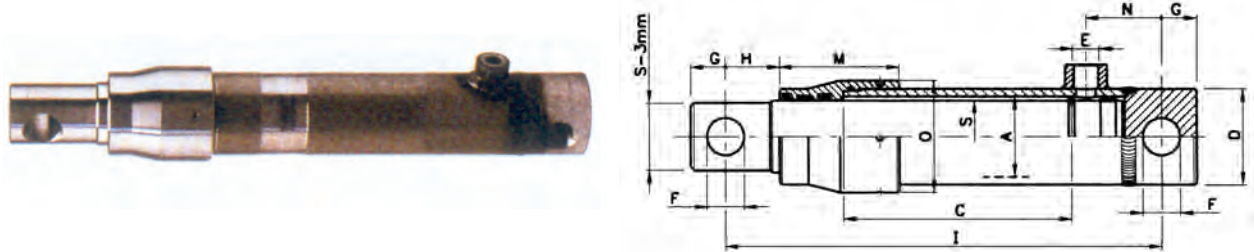

**CARACTERÍSTICAS TÉCNICAS / CARACTÉRISTIQUES TECHNIQUES / TECHNICAL SPECIFICATIONS:**

**Camisa / Cylinder tube / Alésage:** "Lucido" ISO H9, DIN 2393 St 52. 3 / Polished Tube

**Vástago / Piston Rod / Tige:** UNI 5332 C45

**Cabeza / Head Bush / Tête:** Acero DIN St. 52,2 / Steel / Acier

**Junta de Camisa / Joint of Cylinder Tube / Joint de tige:** PU

**Rascador / Wiper / Racleur:** PU

**Junta Tórica / O'ring / Joint torique statique:** Nitrilo / Nitrile

**Temperatura / Temperature / Temperature:** -30°C +110°C

**Presión máxima de trabajo: 210 bar / Max. Working Pressure: 210 bar / Pression máx. travail: 210 bar**

Referencia Part No. Référence	ØS	ØA	C	I	Kg.	ØD	E	ØF	G	H	M	N	O	Kg./100Bar	€
SE45200	45	50	200	330	8	60	3/8 gas	23,4	22	34	75	47	70	1.590	164,11
SE45300			300	430	10										183,41
SE45400			400	530	12										200,88
SE45550			550	680	15										220,74
SE45700			700	830	18										238,37
SE50200	50	55	200	360	11,5	65	3/8 gas	25,5	25	49	80	50	75	1.960	183,22
SE50300			300	460	14										202,47
SE50400			400	560	16										227,89
SE50550			550	710	19,5										251,85
SE50700			700	860	23										271,91
SE55300	55	60	300	460	15,5	70	3/8 gas	25,5	25	41	95	50	85	2.270	243,92
SE55550			550	710	22,5										306,87
SE55700			700	860	26,5										345,10
SE60200	60	65	200	360	15	75	3/8 gas	25,5	25	36	95	50	89	2.820	222,56
SE60300			300	460	18										258,53
SE60400			400	560	21										283,26
SE60550			550	710	25,5										322,61
SE60700			700	860	30										366,44

## CILINDROS DE DOBLE EFECTO

### DOUBLE ACTING CYLINDER - TYPE F

### VÉRIN DOUBLE EFFET

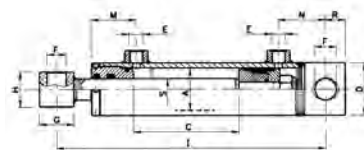

**Presión máxima de trabajo: 210 bar / Max. Working Pressure: 210 bar / Pression máx. travail: 210 bar**

Referencia Part No. Référence	ØS	ØA	C	I	Kg.	ØD	E	ØF	ØG	H	M	N	R	Kg./100Bar	€
DECC2032050	20	32	50	205	2	40	1/4 gas	16,4	28	35	43	38	17	800	89,33
DECC2032100			100	255	2,5										92,36
DECC2032150			150	305	3										95,40
DECC2032200			200	355	3										98,44
DECC2032250			250	405	3,5										101,47
DECC2032300			300	455	3,5										104,51
DECC2540100	25	40	100	270	3,5	50	3/8 gas	20,5	35	40	43	45	19	1.250	103,20
DECC2540150			150	320	4										109,43
DECC2540200			200	370	4,5										110,32
DECC2540250			250	420	5										113,88
DECC2540300			300	470	5,5										119,38
DECC2540400			400	570	6,5										127,18
DECC2540500			500	670	7,5										137,55
DECC3050100	30	50	100	300	5,5	60	3/8 gas	25,5	45	45	46	58	25	1.960	120,11
DECC3050150			150	350	6										124,25
DECC3050200			200	400	6,5										128,39
DECC3050250			250	450	7,5										132,52
DECC3050300			300	500	8										136,61
DECC3050400			400	600	9										148,44
DECC3050500			500	700	10,5										158,39
DECC3050600			600	800	11,5										168,34
DECC3050700			700	900	13										178,02
DECC3050800			800	1000	14										189,54
DECC3050900															202,11
DECC3060100	30	60	100	300	6,5	70	3/8 gas	25,5	45	45	51	58	25	2.820	128,33
DECC3060150			150	350	7,5										133,99
DECC3060200			200	400	8										139,64
DECC3060250			250	450	8,5										145,30
DECC3060300			300	500	9,5										150,95
DECC3060350			350	550	10										156,61
DECC3060400			400	600	11										162,26
DECC3060450			450	650	11,5										167,34
DECC3060500			500	700	12										173,57
DECC3060600			600	800	13,5										200,56
DECC3060700			700	900	15										209,76
DECC4070200	40	70	200	410	11	80	3/8 gas	30,5	54	55	51	58	25	3.840	175,41
DECC4070250			250	460	11,5										181,69
DECC4070300			300	510	12,5										188,23
DECC4070350			350	560	13,5										194,78
DECC4070400			400	610	14,5										209,96
DECC4070450			450	660	15,5										214,68
DECC4070500			500	710	16,5										216,51
DECC4070600			600	810	18,5										229,38
DECC4070700			700	910	20,5										255,66
DECC4080200	40	80	200	410	14,5	92	3/8 gas	30,5	54	55	62	58	25	5.020	225,93
DECC4080250			250	460	15,5										266,40
DECC4080300			300	510	17										216,40
DECC4080350			350	560	18										251,85
DECC4080400			400	610	19										238,16
DECC4080500			500	710	21,5										271,49
DECC4080600			600	810	23,5										269,18
DECC4080700			700	910	26										299,76
DECC50100300	50	100	300	545	29	115	3/8 gas	30,5	54	70	81	60	34	7.850	362,07
DECC50100400			400	645	32,5										388,51
DECC50100500			500	745	36										415,22
DECC50100700			700	945	43										522,76
DECC50100900			900	1145	50										592,87
DECC70120500	70	120*	500	770	62	140	1/2 gas	40,5	70	80	81	65	40	11.300	926,23
DECC701201000			1000	1270	93,5										1.337,46

\* Acabado en H8 / Finished in H8 / Tige chromée en H8

DEPÓSITOS

BOMBAS Y  
DIVISORESMOTORES  
ELÉCTRICOS

VÁLVULAS

DISTRIBUIDORES

ELECTROVÁLVULAS

EMPUÑADURAS

ACUMULADORES

CILINDROS

VARIOS

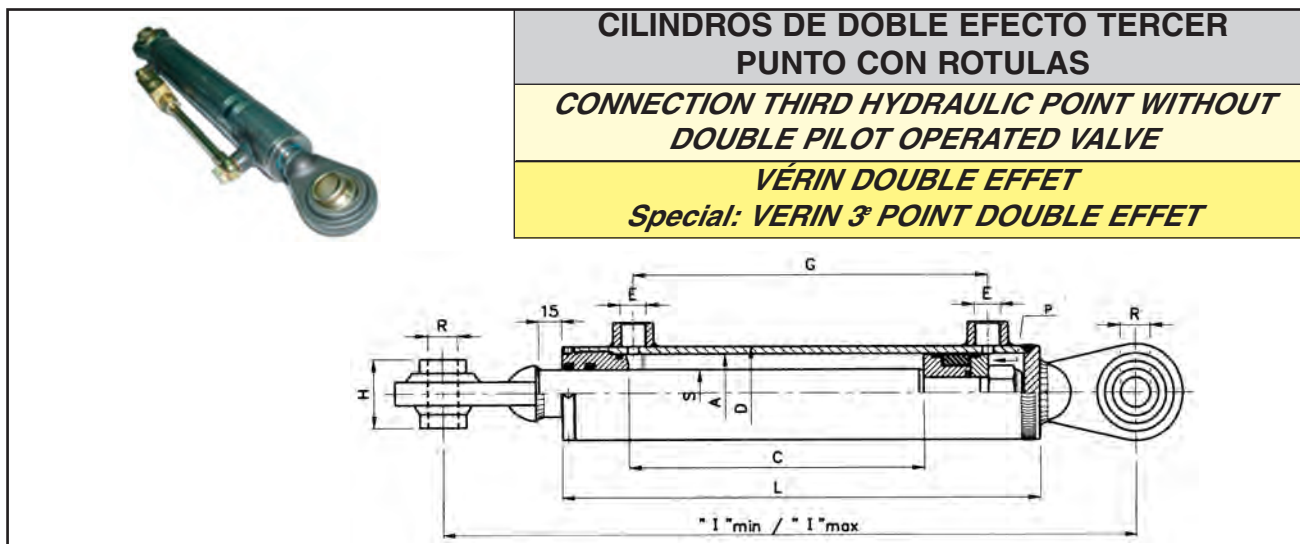

**CILINDROS DE DOBLE EFECTO TERCER PUNTO CON ROTULAS**  
**CONNECTION THIRD HYDRAULIC POINT WITHOUT DOUBLE PILOT OPERATED VALVE**  
**VÉRIN DOUBLE EFFET**  
**Special: VERIN 3° POINT DOUBLE EFFET**

Referencia Part No. Référence	ØS	ØA	C	L	LONGITUD LENGHT LONGUEUR l/min - l/max	Kg.	ØD	E	G	H	ØR	P Kg 100 Bar	€ sin válvula € without valve € sans valve
DECC3050160CR19	30	50	160	177	416/576	5,6	60	3/8 gas	198	44	19,3	1.960	155,21
DECC3050210CR19			210	327	466/676	6,2			248				179,85
DECC3050280CR19			280	397	536/816	7,1			318				173,11
DECC3050400CR19			400	517	656/1056	8,5			438				183,22
DECC3050160CR25	30	50	160	277	426/586	6,3	60	3/8 gas	198	51	25,3	1.960	167,49
DECC3050210CR25			210	327	476/686	6,9			248				146,97
DECC3050280CR25			280	397	546/826	7,9			318				155,40
DECC3050400CR25			400	517	666/1066	9,2			438				166,46
DECC3565160CR25	35	65	160	286	440/600	8,4	75	3/8 gas	199	51	25,3	3.310	191,09
DECC3565210CR25			210	335	490/700	9,3			249				207,95
DECC3565280CR25			280	408	560/840	10,4			319				214,70
DECC3565400CR25			400	526	680/1080	12,3			439				240,55
DECC4080160CR25	40	80	160	312	461/621	12,5	92	3/8 gas	210	51	25,3	5.020	231,56
DECC4080210CR25			210	362	511/721	13,7			260				231,58
DECC4080280CR25			280	432	581/861	15,2			330				245,14
DECC4080400CR25			400	552	701/1101	18			450				267,23
Convertor de 25 a 19 / Change de Ø 25 a Ø 19													-

**Válvula de Bloqueo, tubos y racores ver página 81**  
 Kit double pilot operated valve see page 81  
 Clapet antiretour, tubes et raccord voir page 81

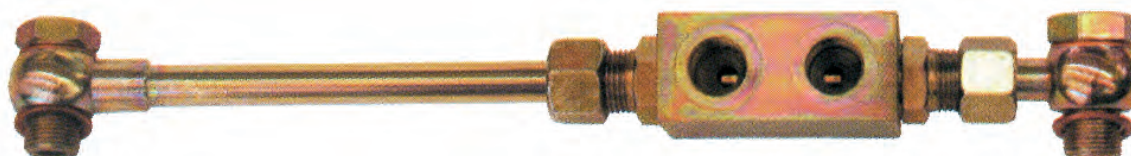

## Juego de Juntas para Cilindro Doble Efecto



*Kits of Joints for D.E. Cylinder*

*Kit de Joints pour D.E. Vérin*

REFERENCIA PART NO. RÉFÉRENCE	CILINDRO CYLINDER VÉRIN	€
JRDECC2032	DECC2032	8,66
JRDECC2540	DECC2540	9,33
JRDECC3050	DECC3050	9,89
JRDECC3060	DECC3060	10,57
JRDECC4070	DECC4070	11,80
JRDECC4080	DECC4080	12,93
JRDECC50100	DECC50100	16,86
JRDECC70120	DECC70120	19,67

## Juego de Juntas para Cilindro Simple Efecto



*Kits of Joints for S.E. Cylinder*

*Kit de Joints pour S.E. Vérin*

REFERENCIA PART NO. RÉFÉRENCE	CILINDRO CYLINDER VÉRIN	€
JRSE25	SE25	5,96
JRSE30	SE30	6,07
JRSE40	SE40	6,86
JRSE45	SE45	8,77
JRSE50	SE50	8,99
JRSE55	SE55	9,22
JRSE60	SE60	9,44

## Rótulas Soldar en Vástago



*Ball-and-Socket Joint to Weld in Rod*

*Rotule à Souder en Tige*

REFERENCIA PART NO. RÉFÉRENCE	DIAMETRO ROTULA DIAMETER BALL-AND-SOCKET JOINT DIAMÈTRE ROTULE	€
ROTV19	19	14,05
ROTV20	20	15,74
ROTV25	25	16,86
ROTV30	30	25,29
ROTV35	35	29,79
ROTV40	40	55,64

## Rótulas Soldar en Culote



*Ball-and-Socket Joint to Weld in Culotte*

*Rotule à Souder en Culot*

REFERENCIA PART NO. RÉFÉRENCE	DIAMETRO ROTULA DIAMETER BALL-AND-SOCKET JOINT DIAMÈTRE ROTULE	€
ROTC19	19	15,18
ROTC22	22	15,18
ROTC25	25	19,67
ROTC28	28	23,61
ROTC30	30	25,85
ROTC35	35	30,91

## Horquillas Soldar



*Yoke to Weld*

*Fourchette à Souder*

REFERENCIA PART NO. RÉFÉRENCE	DIAMETRO ROTULA DIAMETER BALL-AND-SOCKET JOINT DIAMÈTRE ROTULE	€
HOR16	16	15,18
HOR20	20	17,99
HOR25	25	27,54
HOR30	30	49,46
HOR35	35	77,00



**CILINDROS ESPECIALES**  
SPECIAL CYLINDRES  
VÉRINS SPÉCIAUX

	<b>Cilindros Agrícolas</b>					
	<i>Agricultural Cylinders</i>					
	<i>Vérins Agricoles</i>					
	REFERENCIA PART NO. RÉFÉRENCE	Ø VÁSTAGO PISTON ROD TIGE	Ø CAMISA CYL. TUBE ALESAGE	Ø CARRERA STROKE COURSE	DESCRIPCIÓN DESCRIPTION DESCRIPTION	€
<b>DOBLE EFECTO / DOUBLE ACTING / DOUBLE EFFET</b>						
DE2035105	20	35	105	Marcador	238,80	
DE2035150	20	35	150	Compuerta Cuba	166,09	
DE2035300	20	35	300	Clayson Tubo	213,71	
DE2040190	20	40	190	Cilindro Lanza	186,04	
DE3560340	35	60	340	Sermentadora	302,48	
<b>SIMPLE EFECTO / SINGLE ACTING / SIMPLE EFFET</b>						
FRENO	23	-	100	Freno	38,22	
SE2235SOPORTE	22	-	35	Despestillador con soporte	61,31	
SE2360	23	-	60	Despestillador	47,03	
SE35350	35	-	350	Carro pacas	114,45	
SE3590	35	-	90	Trailla con muelle	127,95	
SE40100	40	-	100	Trailla sin muelle	106,13	
SE40340	40	-	340	Sermentadora	132,64	
SE50500	50	-	500	Clayson	307,76	
SE50665TX	50	-	665	Clayson TX 32/34	363,45	



	<b>Cilindros Telescópicos con Muñones</b>		
	<i>Single Acting Telescopic Cylinders</i>		
	<i>Vérins Telescopiques avec Tourillons</i>		
	REFERENCIA PART NO. RÉFÉRENCE	DESCRIPCIÓN DESCRIPTION DESCRIPTION	€
CT479003E	3 Expansiones 47x900	797,22	
CT4710503E	3 Expansiones 47x1050	824,37	
CT6410503E	3 Expansiones 64x1050	1.111,40	
CT8410503E	3 Expansiones 84x1050	1.225,73	
CT477002E	2 Expansiones 47x700	511,32	
CT609002E	2 Expansiones 60x900	659,48	
CT647002E	2 Expansiones 64x700	690,38	
CT6410002E	2 Expansiones 64x1000	793,24	

**Proyecto y suministro de cualquier tipo de cilindro, tanto industrial como agrícola, hasta presiones de 600 kg/cm<sup>2</sup>.  
EXISTENCIA CONSTANTE, SALVO VENTA.**

Project and supply of any kind of cylinder, such as industrial as agricultural. Upto pressures of 600 kg/cm<sup>2</sup>.  
CONSTANT STOCK, UNLESS SOLD.

*Projet et fourniture de tout type de vérin, autant industriel comme agricole, jusqu'a des pressions de 600kg/cm<sup>2</sup>  
STOCK CONSTANT, SAUF VENTE.*

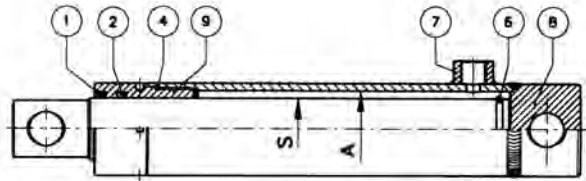
**CILINDROS SIMPLE EFECTO**  
**SINGLE ACTING CYLINDER**  
**VÉRINS SIMPLE EFFET**

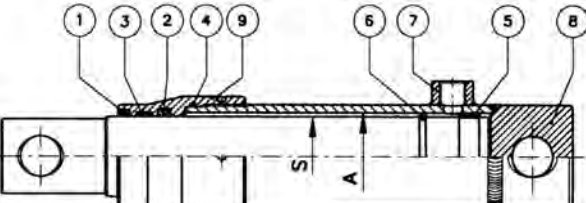
**KIT DE JUNTAS PARA CILINDROS SIMPLE EFECTO**  
**SEAL KIT FOR SINGLE ACTING CYLINDER**  
**KIT DE JOINTS POUR VÉRINS SIMPLE EFFET**

	 <p>             1 rascador / wiper / racleur              2 collar / joint cyl. tube / joint tige              3 anillo roce / guide              4 junta tórica / o ring / o ring              5 anillo roce / guide         </p>
--	--

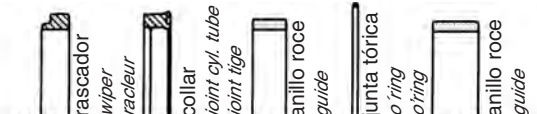
**CILINDROS DOBLE EFECTO**  
**DOUBLE ACTING CYLINDER**  
**VÉRINS DOUBLE EFFET**

	
---	--

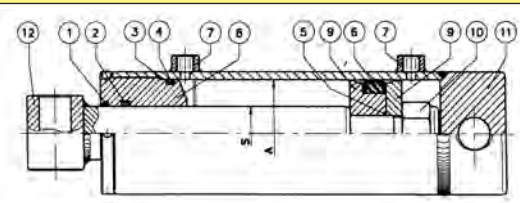
**KIT DE JUNTAS PARA CILINDROS DOBLE EFECTO**  
**SEAL KIT FOR DOUBLE ACTING CYLINDER**  
**KIT DE JOINTS POUR VÉRINS DOUBLE EFFET**

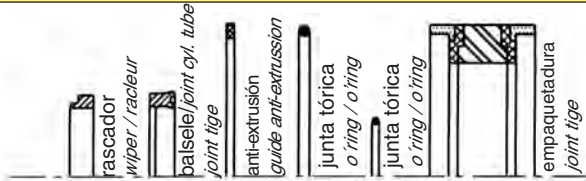
	 <p>             1 rascador / wiper / racleur              2 balseo / joint cyl. tube / joint tige              3 anti-extrusión / guide anti-extrusion              4 junta tórica / o ring / o ring              5 junta tórica / o ring / o ring              6 empaquetadura / joint tige "chevron"         </p>
---	--



ACCESORIOS PARA CILINDROS / ACCESSORIES FOR HYDRAULIC CYLINDERS / ACCESSOIRES POUR VÉRINS HYDRAULIQUES

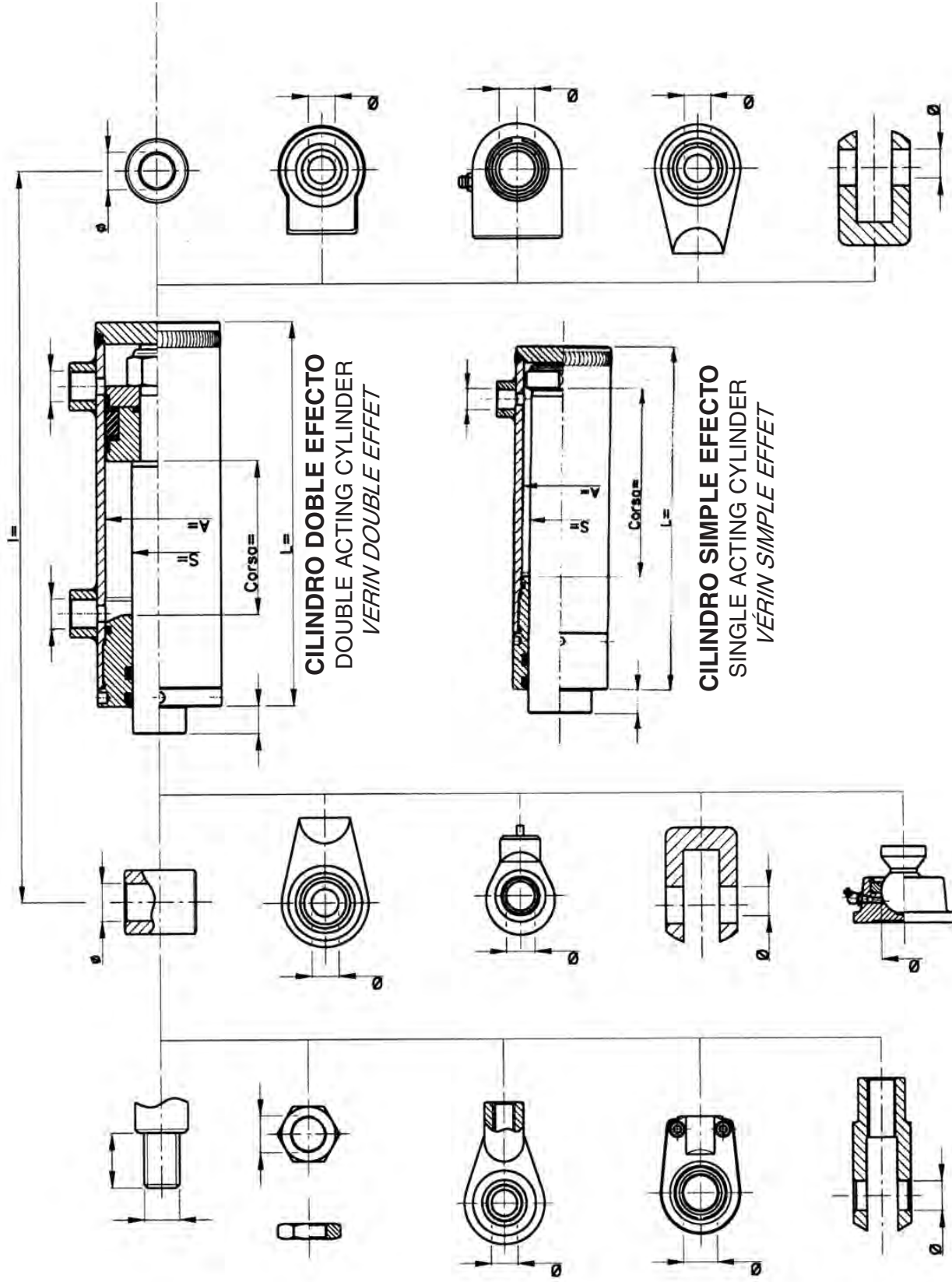

Disponemos de una amplia gama de accesorios, consútenos

We have a big range of accessories. Please, enquire us

On dispose d'une ample gamme d'accessoires. Demandez-nous